

Circle Theorems

Find the measure of the arc or angle indicated.

1)

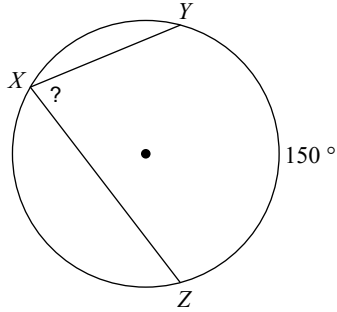

2)

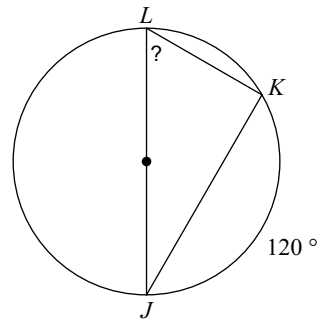

3)

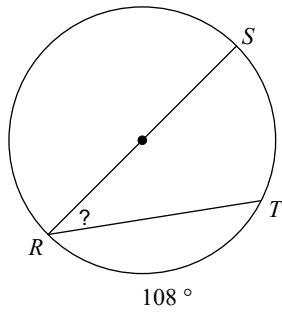

4)

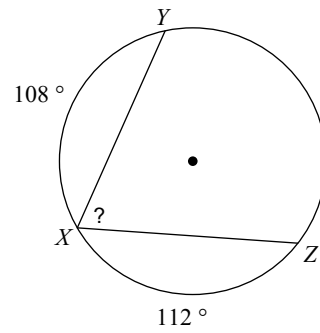

5)

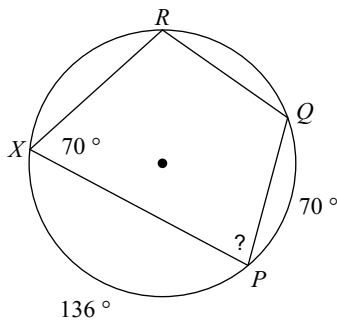

6)

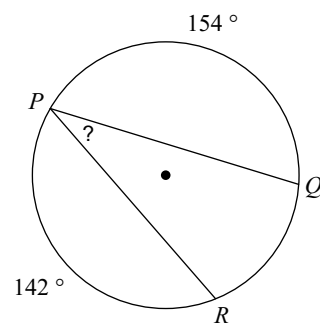

7)

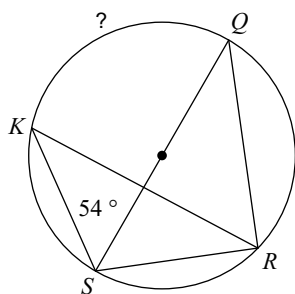

8) Find $m\widehat{YXW}$

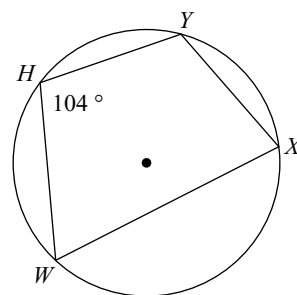

9)

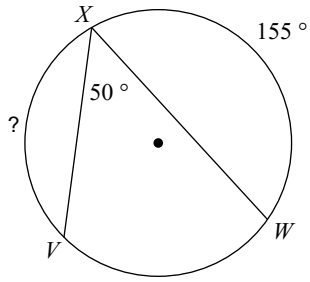

10)

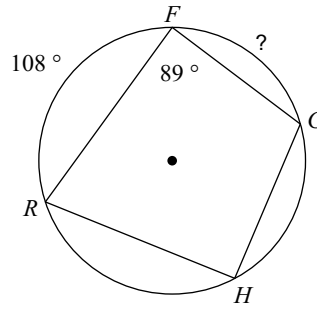

Solve for x .

11)

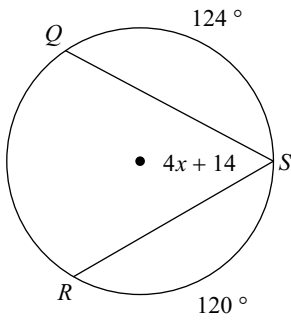

12)

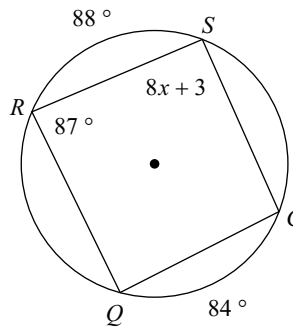

Find the measure of the arc or central angle indicated. Assume that lines which appear to be diameters are actual diameters.

13) $m\angle XUY$

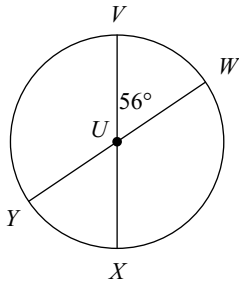

14) $m\widehat{YV}$

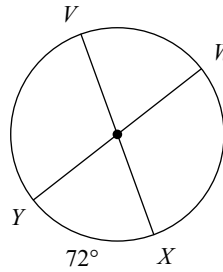

Find the length of the segment indicated. Round your answer to the nearest tenth if necessary.

15)

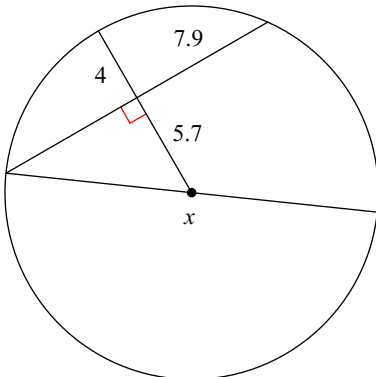

16)

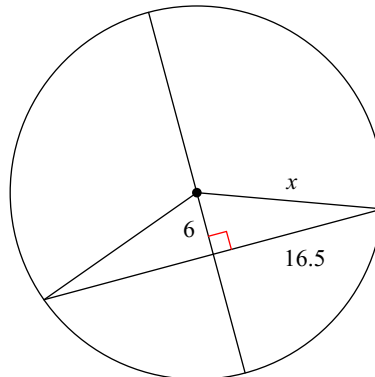

Find the measure of the arc or angle indicated. Assume that lines which appear tangent are tangent.

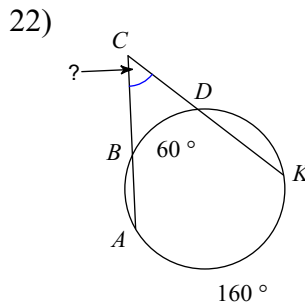
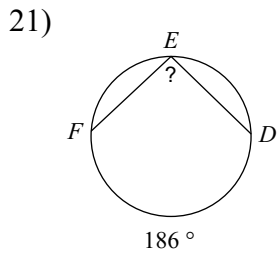
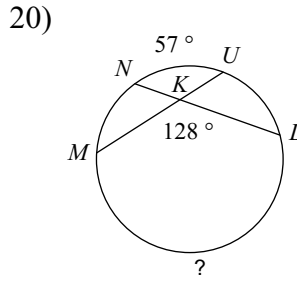
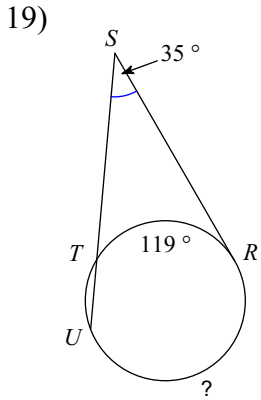
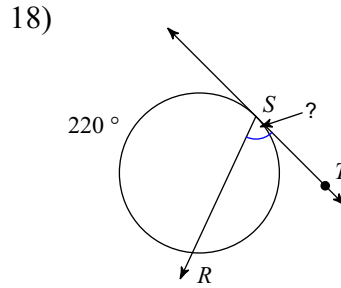
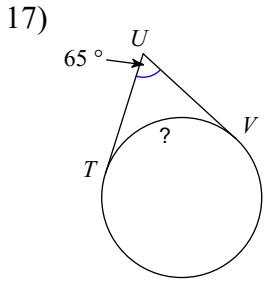

Solve for x . Assume that lines which appear tangent are tangent.

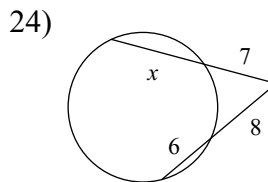
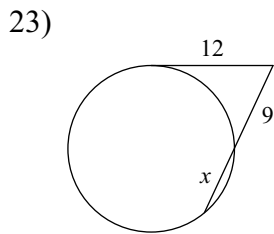

Solve for x . Assume that lines which appear to be tangent are tangent.

